

TAKSTAR® 得胜



SM18 EL (GEN 2)

专业录音麦克风

Professional Recording Microphone

使用手册 | User Manual

SM18 EL (GEN 2) 专业录音麦克风

■ 前言

尊敬的用户：

感谢您选购得胜SM18 EL (GEN 2)专业录音麦克风，为了您能够更好地了解使用本产品，建议您在使用前仔细阅读本说明书。

若存在有疑问或者您有宝贵的建议，可通过拨打得胜官方服务热线400 6828 333或微信扫描二维码关注得胜官方公众号与我们联系。



■ 产品特性

- 采用 $\Phi 26\text{mm}$ 镀金振膜音头，提供更大的动态范围和快速的瞬态响应；
- 宽广的频响范围，能够准确捕捉声音的每个细微变化；
- 优化的电路处理，提供优秀的信噪比，声音更干净透彻；
- 优越的声压级表现，适合拾取人声及各类乐器等音源；
- 锌合金本体配以香槟金色彩，赋予气派格调，有效屏蔽电磁干扰；
- 配置专业防震架，橡皮筋悬吊设计增加安装稳定性，降低震动声传导；
- 双层金属防喷网，两网之间保留隔离间距，有效过滤喷麦声及气流声。

■ 适用范围

人声录制、专业录音、网络直播、乐器录音等

■ 标准配置

麦克风.....	1支	橡皮筋.....	2条
防震架.....	1个	说明书.....	1份
防喷网.....	1个		

SM18 EL (GEN 2) 专业录音麦克风

■ 技术参数

- 音头: $\Phi 26\text{mm}$ 镀金振膜音头
- 指向性: 单指向
- 频率响应: 20Hz-20kHz
- 灵敏度: $-32\text{dB} \pm 3\text{dB}$ ($0\text{dB}=1\text{V}/\text{Pa}$ at 1kHz)
- 等效噪声级: $\leq 20\text{dBA}$ (IEC 581-5)
- 峰值声压级: 130dB ($\text{THD} \leq 1\%$ at 1kHz)
- 输出阻抗: $100\Omega \pm 30\%$ (at 1kHz)
- 工作电压: 48V幻象电源
- 单体尺寸: $157\text{mm} * 55\text{mm} * 38\text{mm}$
- 单体重量: 约323g

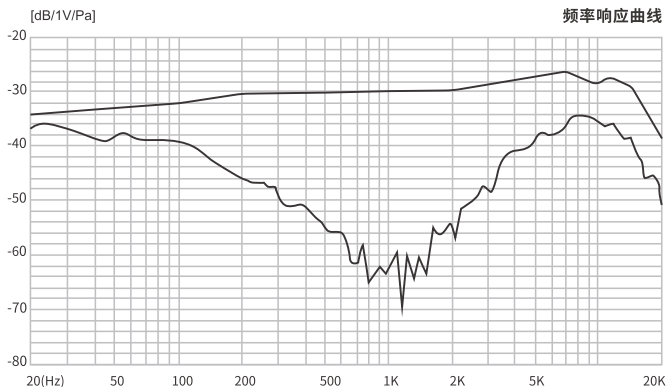
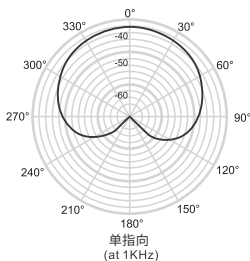

SM18 EL (GEN 2) 专业录音麦克风

■ 使用说明

1. 将防震架安装到麦克风支架或吊杆上，并旋紧防震架上的固定螺母。建议防震架安装固定好后正面朝上，底部螺母朝下，以防麦克风夹不紧时从防震架中脱落造成损坏。

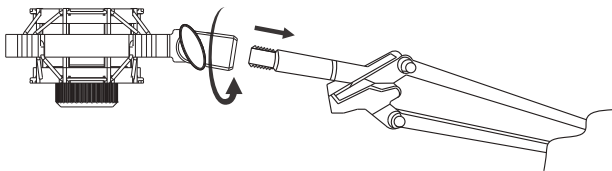

2. 麦克风安装到防震架中，旋紧防震架底部的螺母直至完全夹紧麦克风，再通过防风网上的卡扣将防风网安装到防震架上；

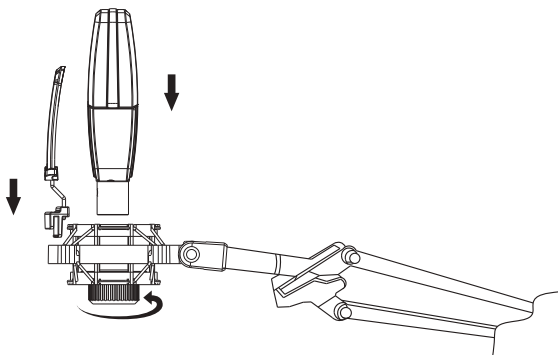

SM18 EL (GEN 2) 专业录音麦克风

3. 麦克风印有“SM18 EL”产品型号和一个“○”指向性标记的一面为正面, 确保将麦克风的正面对准声源, 人与麦克风建议保持20-30厘米的拾音距离, 如下图所示:

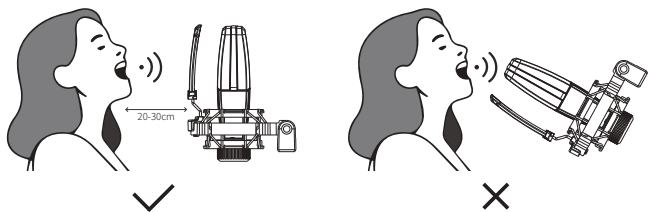

4. 将麦克风的接口通过公母卡侖线连接到具有48V幻象电源的音频设备(如声卡、调音台、功放等), 如果设备本身没有幻象电源, 则需要另购一个48V幻象电源进行连接。

注意: 本产品需求的48V幻象电源规格: DC 48V±4V/2.8mA±20%

① 音频设备带48V供电的连接方法:

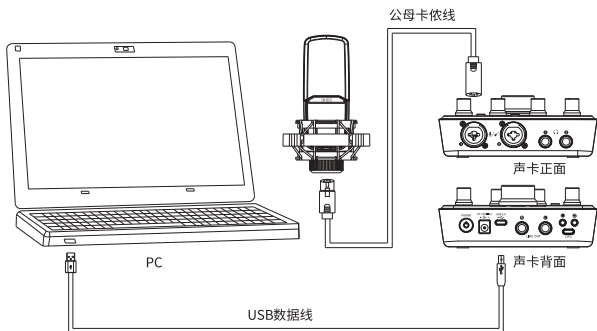

SM18 EL (GEN 2) 专业录音麦克风

② 音频设备不带48V供电的连接方法：

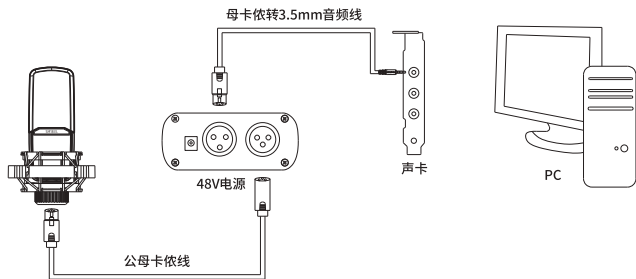

5. 将连接线固定在麦克风支架或吊杆上，在麦克风位置预留一圈连接线，这种做法可实现有效的隔震效果。

6. 使用时，应先将设备音量调小，再打开幻象电源开关，并将音量从小到大慢慢调节至合适，以免声压过大对扬声器产生冲击；尽可能的拉开麦克风与扬声器的距离，避免麦克风和扬声器相对，从而有效控制回馈啸叫。

7. 麦克风输出接口是三针XLRM接口，其极性如图所示：

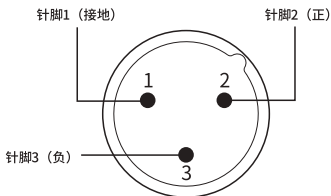

■ 安全警示

为避免电击、高温、着火、辐射、爆炸、机械危险以及使用不当等可能造成的人身伤害或财产损失，使用本产品前，请仔细阅读并遵守以下事项：

1. 使用产品时请确认所连设备与本产品是否匹配以及合理调整音量大小，不要在超过产品功率及大音量下长时间使用，以免造成产品异常；
2. 使用中若发现有异常（如冒烟、异味等），请立即关闭电源开关并拔掉电源插头，然后将产品送售后服务网点检修；
3. 消费者若使用电源适配器供电，则应购买配套使用获得CCC认证并满足标准要求电源适配器；
4. 本产品及配件都应放置在室内干燥通风处，请勿长期存放在潮湿、灰尘多的环境，使用中避免靠近火源、雨淋、进水、过度碰撞、抛掷、振动本机及覆盖通风孔，以免损坏其功能；
5. 使用该产品时需遵守相关安全规定，法律法规明确禁止使用场合请勿使用本产品，以免导致意外事故；
6. 请不要自行拆机改装或维修，以防止出现人身伤害，如有问题或服务需求请联系当地售后服务网点跟进处理；

SM18 EL (GEN 2) 专业录音麦克风

■ 环保说明

产品中有毒有害物质或元素的名称及含量标识表

部件名称	有毒有害物质或元素									
	铅 (Pb)	汞 (Hg)	镉 (Cd)	六价铬 (Cr(VI))	多溴联苯 (PBB)	多溴二苯醚 (PBDE)	邻苯二甲酸 二正丁酯 (DBP)	邻苯二甲酸 二异丁酯 (DIBP)	邻苯二甲酸 丁基苄酯 (BBP)	邻苯二甲酸 二(2-乙基)己酯 (DEHP)
塑料部件	○	○	○	○	○	○	○	○	○	○
金属部件	×	○	○	○	○	○	○	○	○	○
电路板组件	×	○	○	○	○	○	○	○	○	○
线缆	×	○	○	○	○	○	○	○	○	○

本表格依据SJ/T 11364的规定编制。

○ : 表示该有害物质在该部件所有均质材料中的含量均在GB/T 26572规定的限量要求以下。

× : 表示该有害物质至少在该部件的某一均质材料中的含量超出GB/T 26572规定的限量要求。

此标志为产品的环保使用期限标志，
且此环保使用期限只适用于产品正常工作的温度和湿度等条件。



SM18 EL (GEN 2) 专业录音麦克风

■ 关于图标含义解释

 根据RL2004/108/EG和European Low Voltage Directive (欧洲低电压指令) RL2006/95/EG的测试结果表明,本产品符合欧共体关于电磁兼容性的成员国法律整合的指令中所规定的限值。

 未经合规方明确批准的变更或修改可能会使用户失去操作设备的权限。此设备符合FCC规则第15条部分的要求。操作须符合以下两个条件:

- (1) 此设备可能不会造成有害干扰,
- (2) 此设备必须接受接收到的任何干扰,包括可能导致意外操作的干扰。

 此符号表示,根据WEEE指令(2012/19/EU)和国家法律,由于这种类型的废弃物会有潜在的有害物质,可能对环境 and 人类健康产生负面影响,所以本产品不应与您的家庭垃圾一起处置,应将本产品交由授权的电气和电子设备(WEEE)回收站回收。同时,您在正确处理本产品的同时将有助于自然资源的有效利用。如需了解更多有关您可以在何处放置废物回收设备的信息,请联系您当地的城市办事处、废物管理局或家庭废物处理服务部门。

■ 关于本说明书

本说明书中内容符合截止印刷之日的技术规格。由于得胜公司会不断改进产品,本说明书可能不符合您的特定产品的技术规格。要获取最新版说明书,请访问得胜官网,然后下载说明书文件。技术规格、设备或另售的附件在各个地区可能有所不同,如有问题请与当地得胜销售网点确认。如需更多支持和深层产品信息,请浏览得胜官方网站: <https://www.takstar.com>

版权所有 ©2025 得胜。得胜、TAKSTAR及其各自标志是得胜公司在中国和/或其他国家/地区的注册商标或商标。所有其它商标均是其各自所有者的财产。

■ Preface

Dear Customer,

Thanks for purchasing our product. Read this manual thoroughly for proper use.

If you have any questions or suggestions, please contact our local sales service.

■ Features

- Ø26mm Capsule with Gold-Plated Diaphragm: Wide dynamic range and fast response.
- Broad Frequency Response: Captures subtle sound nuances.
- Optimized Circuitry: Excellent signal-to-noise ratio for clearer audio.
- High Sound Pressure Level: Ideal for vocals and instruments.
- Zinc Alloy Body: Elegant champagne gold finish with EMI shielding.
- Shock Mount: Rubber suspension enhances stability, reduces vibrations.
- Dual-layer Metal Pop Filter: Minimizes plosive and air noise.

■ Applications

Vocal recording, professional recording, live streaming, instrument recording.

■ Package Contents

- | | | |
|-----------------|-----------------|-----------------|
| 1 × Microphone | 1 × Pop Filter | 2 × Rubber Band |
| 1 × Shock Mount | 1 × User Manual | |

SM18 EL (GEN 2) Professional Recording Microphone

■ Specifications

- Capsule: Ø26mm, gold-plated diaphragm capsule
- Polar Pattern: Unidirectional
- Frequency Response: 20Hz - 20kHz
- Sensitivity: -32dB \pm 3dB (0dB=1V/Pa at 1kHz)
- Equivalent Noise Level: \leq 20dBA (IEC 581-5)
- Maximum SPL: 130dB (THD \leq 1% at 1kHz)
- Output Impedance: 100 Ω \pm 30% (at 1kHz)
- Operating Voltage: 48V Phantom Power
- Dimensions: 157 * 55 * 38 mm
- Weight: Approx. 323g

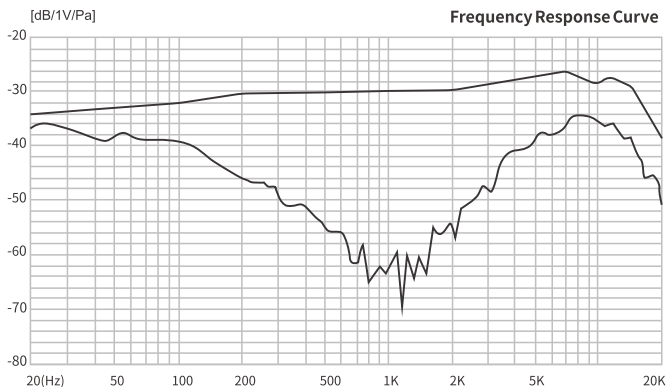
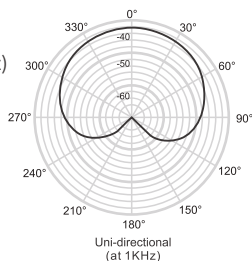

■ Operating Instructions

1. Assemble the shock mount onto the mic stand or boom arm, and tighten the fixing nut on the shock mount. It is recommended to keep the shock mount upwards and bottom screw downwards, to prevent accidental mic drop and damage in case of loose mic clamping.

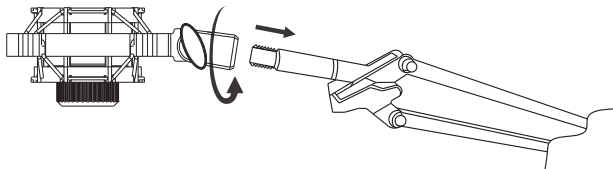

2. Install the mic onto the shock mount by tightening the bottom screws until fully secured. Fasten the pop screen onto the shock mount via the bottom clip.

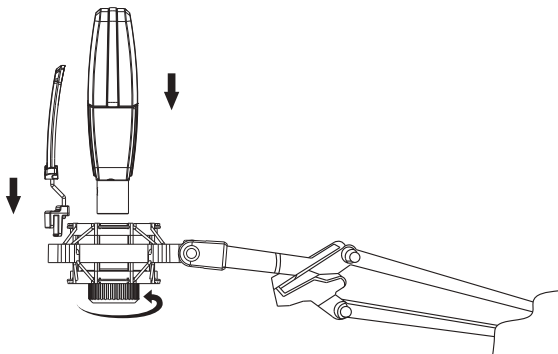

SM18 EL (GEN 2) Professional Recording Microphone

3. The front side of the mic is the side with the silkscreened "SM-18 EL" and "☉" pattern. Face the front side towards the sound source, maintain a recommended distance of 20-30cm between the speaker and the mic, as shown below.

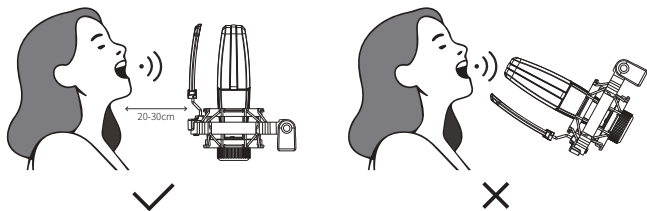

4. Connect the mic to an audio device (e.g., audio interface, mixer, power amp) with a 48V phantom power supply using the included XLR cable. If the device lacks phantom power, purchase a separate supply.

Note: Required phantom power specs: DC 48V \pm 4V / 2.8mA \pm 20%

SM18 EL (GEN 2) Professional Recording Microphone

① For devices with 48V supply:

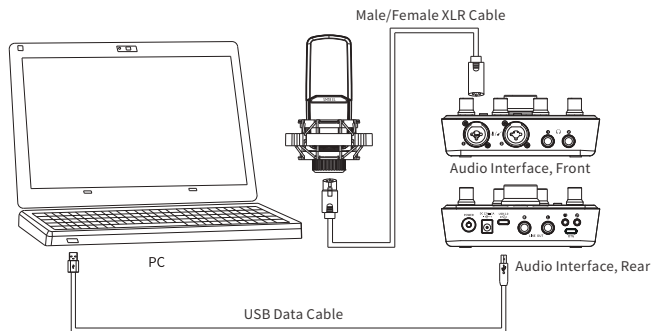

② For devices without 48V supply:

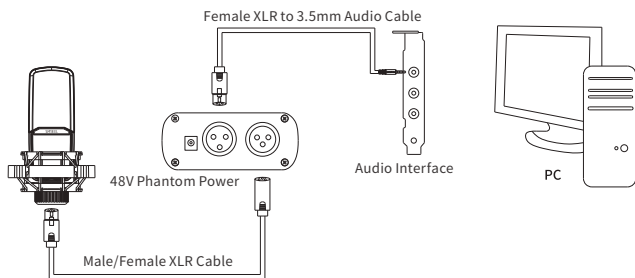

SM18 EL (GEN 2) Professional Recording Microphone

- Secure the connecting cable to the stand or boom arm, leaving a loop at the mic position for shock isolation.
- Set device volume low before turning on the phantom power. Gradually increase volume to avoid damaging speakers. Maintain distance between the mic and speakers without pointing them towards each other to control feedback.
- The mic output features a three-pin XLRM connector. Pin configuration is illustrated as shown:

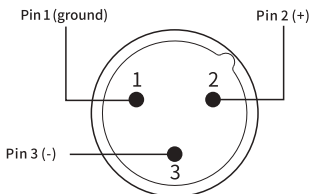

■ Safety Instructions

To avoid electric shock, overheat, fire, radiation, explosion, mechanical risk and injury or property loss due to improper use, please read and observe the following items before use:

- Please check if the power of the connected equipment matches with that of this product before operation. Adjust the volume to proper level during operation. Do not operate at over-power or high-volume level for extended time to avoid product malfunction.
- If there is any abnormality during use (e.g., smoke, strange odor), please kill the power switch and unplug from power source, then send the product to the local dealer for repair.

SM18 EL (GEN 2) Professional Recording Microphone

3. Please use the provided power adapter to charge this product. If you need to use a different adapter, make sure to purchase one that is CCC certified and meets the required standards.
4. Keep this product and its accessories in a dry and ventilated area. Do not store in a humid or dusty area for extended time. Keep away from fire, rain, liquid intrusion, bumping, throwing, vibrating, or from blocking any ventilation openings, to prevent malfunction.
5. Please abide by safety rules during operation. Do not use the product in places prohibited by laws or regulations to avoid accident.
6. Do not disassemble or repair the product by yourself to avoid injury. If you have any questions or require any services, please contact our local dealer.

■ Label Meanings

 This device is compliant with the limits of the European Council Directive on the approximation of the laws of the member states relating to electromagnetic compatibility according to RL2004/108/EG and European Low Voltage Directive RL2006/95/EG.

SM18 EL (GEN 2) Professional Recording Microphone



Note: This equipment has been tested and found to comply with the limits for a Class B digital device, pursuant to part 15 of the FCC Rules. These limits are designed to provide reasonable protection against harmful interference in a residential installation. This equipment generates, uses, and can radiate radio frequency energy and, if not installed and used in accordance with the instructions, may cause harmful interference to radio communications. However, there is no guarantee that interference will not occur in a particular installation. If this equipment does cause harmful interference to radio or television reception, which can be determined by turning the equipment off and on, the user is encouraged to try to correct the interference by one or more of the following measures:

- Reorient or relocate the receiving antenna.
- Increase the separation between the equipment and receiver.
- Connect the equipment to an outlet on a circuit different from that to which the receiver is connected.
- Consult the dealer or an experienced radio/TV technician for help.

Changes or modifications not expressly approved by the complying party may cause the user to lose permission to operate the device.

This device complies with part 15 of the FCC Rules. Operation is subject to the following two conditions:

- 1) This device may not cause harmful interference, and
- 2) This device must accept any interference received, including interference that may cause undesired operation.

SM18 EL (GEN 2) Professional Recording Microphone



This symbol indicates that this product should not be disposed of with your household waste, according to the WEEE directive (2012/19/EU) and your national law. This product should be handed over to an authorized collection site for recycling waste electrical and electronic equipment (WEEE). Improper handling of this type of waste could have a possible negative impact on the environment and human health due to potentially hazardous substances that are generally associated with WEEE. At the same time, your cooperation in the correct disposal of this product will contribute to the effective usage of natural resources. For more information about where you can drop off your waste equipment for recycling, please contact your local city office, waste authority, or your household waste disposal service.

■ About This Manual

This manual contains up-to-date technical specifications as of printing. However, specifications contained herein may not conform to your particular product since Takstar is constantly improving its products. Also, specifications, devices or accessories available may vary from region to region. If you have any questions, please contact our local sales outlet. For the latest version/more information, please visit our website: <https://www.takstar.com/>

Copyright ©2025 TAKSTAR. TAKSTAR, 得胜 and their respective logos are registered trademarks or trademarks of Takstar company in the PRC, and/or other countries. All other trademarks are the property of their respective owners.

注意事项:

1. 本单为保修凭证, 请用户妥善保管, 如有遗失, 恕不保修或退换。
2. 保修期限制: 购买之日起2年内。
3. 除了不可抗力事件损坏外, 由本公司负责, 免费维修。
4. 如属保管不善或使用不当造成的损坏, 维修点将酌情收费。
5. 擅自拆卸维修者, 不予保修。
6. 以上保修条款仅限于中国市场适用 (不含港澳台地区)。

产品服务保证书

姓名: _____ 电话: _____ 地址: _____

商品: _____ 型号: _____ 购买日期: _____ 年 ____ 月 ____ 日

维修记录栏 (由维修员填写)	维修员签名	日期

◆ 广东得胜电子有限公司 ◆ 电话: 400-6828-333 ◆ 地址: 广东省惠州市博罗县龙溪街道富康一路2号



扫一扫, 了解更多产品
Scan for more
product information

广东省电声工程技术研究开发中心 广东得胜电子有限公司制造

地址: 广东省惠州市博罗县龙溪街道富康一路2号

服务热线: 400 6828 333 传真: 0752 6383950

邮箱: xs@takstar.com

网址: www.takstar.com

Designed & Manufactured by:

Guangdong Takstar Electronic Co., Ltd.

Address: No.2 Fu Kang Yi Rd., Longxi Boluo
Huizhou, Guangdong 516121 China

Tel: 86 752 6383644 Fax: 86 752 6383952

Email: sales@takstar.com

Website: www.takstar.com